

Chilly 45 50 Hz



Operating Instructions

Water chiller

OPERATING INSTRUCTIONS



1	SAFETY / PREVENTION OF ACCIDENTS	2
2	TRANSPORT	4
3	INSTALLATION AND INITIAL OPERATION	5
4	CARE AND MAINTENANCE	9
5	FAULT DIAGNOSIS	11
6	IMPORTANT INFORMATION ON WATER QUALITY	14
7	PLATE HEAT EXCHANGER (OPTION)	16
8	WASTE DISPOSAL	16

APPENDIX

- TECHNICAL DATA
- TEMPERATURE CONTROLLER
- WIRING DIAGRAM

These operating instructions have to be read carefully before putting the chiller into operation.

Please observe these instructions, otherwise the manufacturers liability for subsequent damage will be cancelled. All rights required for further technical development and modification, are reserved.

Proper use of the chiller

This chiller is designed for the cooling of water only. For the use of other agents (e.g. deionised water) please contact the manufacturer. Limits indicated in the technical data must be adhered to strictly, otherwise the manufacturers liability for subsequent damage will be cancelled. Chilling of flammable or explosive substances is prohibited.

IMPORTANT!

IMPORTANT!

**Please keep these operating instructions
for further use!**

1 SAFETY / PREVENTION OF ACCIDENTS

General information

These operating instructions contain valuable information which has to be observed during initial start-up, operation and maintenance. Therefore these instructions are to be read by the installer and operating personnel in charge, before putting the chiller into operation.

All general safety instructions mentioned in this chapter and special security instructions given in other sections of this manual have to be observed.

Personnel qualification and training

Operating, maintenance, inspection and installation personnel must be qualified. Responsibility and supervision must be clearly explained to the operator.

Danger due to non-observance of safety instructions

Non-observance of safety instructions may cause injuries, endanger the environment or damage the chiller. Non-observance of safety instructions will cancel the manufacturers liability for subsequent damage.

Safety conscious operation

The safety instructions given in these operating instructions, including national regulations on accident prevention as well as any specific chiller safety instructions must be observed.

Safety instructions for user / operator

Protective guards that have been installed to prevent contact with moving parts may not be removed when the unit is being operated. Danger resulting from the use of electrical power is excluded (for detailed information, refer to the VDE regulations and the regulations of the local power supply authorities).

Safety instructions on maintenance, inspection, and installation work

Basically none of the cleaning or maintenance tasks may be performed until the unit has come to a complete standstill. As soon as this work has been completed, all the safety devices and protective equipment must be mounted or installed according to their proper function.

Arbitrary modification and production of spare parts

The unit may be converted only if an agreement has been reached with the manufacturer. Original spare parts and accessories accepted by the manufacturer serve as safety guarantee. Use of other parts may cancel the manufacturer's liability for subsequent damages

1 SAFETY / PREVENTION OF ACCIDENTS

Non-permissible operating methods

The operational safety of the delivered unit is guaranteed only if the unit is properly used as intended.

Limits indicated in the technical data must not be exceeded

Health hazards with the refrigerant

The refrigerant has only a very low acute health hazard. It has narcotic effects only at extremely high concentrations. After acute exposure to extremely high concentrations the substance is eliminated over the lungs very quickly. The refrigerant has a certain irritating effect on skin and mucous membranes. Exposure of the skin to liquid refrigerant can cause frost bite. In the presence of open flames or hot surfaces refrigerant can decompose and form toxic decomposition products (e.g. hydrogen chloride, phosgene). The refrigerant evaporates when exposed to air. Intentional exposure of refrigerant is not permissible. The chiller must be handled with great care to prevent any damage occurring through transport operations.

Safety symbols



Warning!

This symbol is to be found next to all the safety instructions involving work that may result in serious injuries. Observe these instructions and proceed with extreme caution in such instances. Inform all other users as well. In addition to the instructions included in this manual, the applicable general safety and accident prevention regulations must also be taken into account.



Attention!

This symbol is to be found next to the items in this manual that must be strictly observed to ensure proper application of the guidelines, regulations, instructions and procedure of tasks and to make sure that the machine or other parts are not damaged or destroyed.



Note!

This symbol explains that chiller is designed according to state-of-the-art technology and is safe to operate. Dangerous situations may, however, be the result if the unit is used by personnel without adequate qualification or if it is not used correctly according to its intended purpose. Accordingly, this may affect efficient operation of the unit.

2 TRANSPORT

The chiller may only be transported in original packaging to the site of initial operation. In case of damage the manufacturer must be informed immediately. If the unit is moved to another location in a factory, all connections must be disconnected from the unit. Moving the unit to another location must be carried out without causing damages. If damage occurs despite these instructions, the unit must be checked by an expert and repaired as required before it is put into operation again.



Note:

The Manufacturers Liability excludes any Damage to the Chiller subsequent to Transportation.

**When transporting the unit, consider the weight limits indicated in the technical data.
Use a fork-lift, truck or a crane with the corresponding load-capacity.**

**The fully-hermetic compressor is mounted on rubber. Avoid vibrations during transport.
Failure to observe can result in compressor damage.**

3 INSTALLATION AND INITIAL OPERATION

Installation

Prior to installation and commissioning of the chiller, please observe the following points strictly:

- ***The fresh air intake temperature may not exceed the max.ambient temperature (refer to name plate)***
- Assure that the required quantity of air is available at air cooled chillers.
- **Assure that the chiller hot air outlet does not warm up the environment or room excessively.**
- Min.distance of fresh air intake: at least 0,5 m (air cooled version)
- Min.distance of hot air outlet: at least 1,0 m (air cooled version)
- Connection of an air supply and exhaust duct is not admitted.
- **The fresh air intake of the unit (condensor) may not be situated in front of a heat rejecting device like a pump or electric motor.**
- The unit must be set up on level, solid surfaces only, in order to ensure the required stability.
For outside erected chillers, the minimum outdoor temperature should be considered from the technical data.

Floor space

A minimum space must be left open around the installation, so that there is access to the various components and to the control cabinet.

The distance from any constructions blocking the air supply must be at a minimum distance of 0,5 meter.



3 INSTALLATION AND INITIAL OPERATION

Electrical connection

- 
- The chiller is ready for connection and is connected to a one or three phase current network (mains voltage refer to technical data).
 - The power supply has to be connected in a *right handed rotatory field*. In order to confirm the correct connection the direction of rotation of the fan motor must turn in the same direction as the arrow.
 - All electrical connections in the switch board are to be tightened prior to commissioning.



Incorrect connection of power supply and incorrect power supply will cancel the manufacturers liability for subsequent damage.

Hydraulic connection

After completing the electrical connection it is necessary to connect the Chiller to the consumer VIA flexible or fixed pipes.

- 
- Selection of materials of pipes. PVC, Plastic, Stainless Steel, Copper and Brass are permissible.
Note: Mild Steel and Galvanized Steel is not permissible.
 - Selection of cross – section of pipes (for advise please refer to manufacturer).
 - Insulated pipes are to be used if the distance between the chiller and the consumer is greater than 5 m.
 - Refer to technical data (pump diagram) for flow rate and pressure available from the chiller.
 - Before starting up it is always necessary to prime the pump with the medium to be transported. (refer to BLEEDING OF PUMP in this chapter).
 - If the consumer is placed on a higher level than the chiller unit, a non-return valve has to be recommend in the water outlet as well as an solenoid valve has to be installed in the water inlet.
 - Connect water inlet port to consumer return line.
 - Connect water outlet port to consumer inlet line.
 - Connect water supply port (if available) to city water net.
 - Please test float valve adjustment (option). Float valve is factory adjusted at 3 bar water pressure.



Incorrect hydraulic installation will cancel the manufacturers liability for subsequent damag

Refilling of the tank

Automatic refill

Tap/fresh water feed connected to water supply port guarantees constant level in the tank, so that evaporator always remains submerged.

Manual refill

Filling of water manually through water inlet port or directly into tank.

The waterlevel can be observed by the water sightglass which can be seen from the outside of the housing. Ensure that the evaporator is submerged.

3 INSTALLATION AND INITIAL OPERATION

Important:

Prior to filling of the tank it is essential to test the water quality and if required carry out watertreatment (refer to chapter 7).

To avoid corrosion at the stainless steel evaporator, we recommend to use water with a low salt content (chloride content < 20 mg/l). To avoid thickening of the tank water, we recommend to replace the system content every 1 to 3 months.

- an increasing evaporation of the tank water means an increasing chloride content (→ please refer to chapter 6).
- For chillers running at temperatures lower than freezing point, a water/glycol mixture at the appropriate ratio should be filled.
30% Glycol up to -10°C, at lower temperatures → please refer to the manufacturer.
- The tank should be filled to the max. level of the water level tube.
- Prior to start up it is always necessary to prime the pump with the medium to be transported.
- Prior to start up the pump must be bled in order to remove air from the pump.

Bleeding of the pump

- Remove bleeding screw P (option)
- Reinstall bleeding screw and tighten as soon as medium exits from filler fitting.

Important: Ventilation of the pump

before start the process, following steps are to relize for ventilate the pump:

- check the waterlevel in the tank and refill it, if necessary
- open the outlet of the pump, or
- connect only the outlet of the pump, let the inlet free flow out

If there is still some air in the system, you have to repeat the steps as described before.

After open the outlet start the pump for a short time.

Attention

before start the operation of the pump, the function of this pump must be absolutly check.

In case that the pump after a longer standstill and ventilation stopp, you have to introduce a screwdriver through the airgrille into the shaft and turn it clockwise (1-2 turns min.), until a easiness is produced.

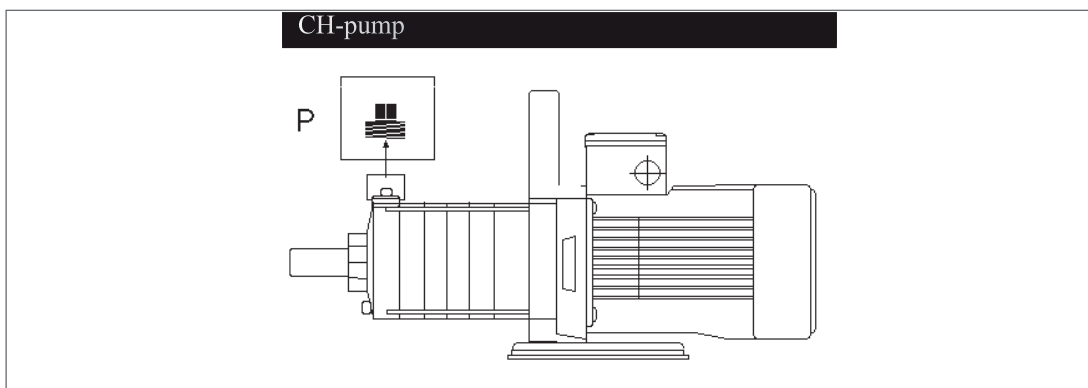

3 INSTALLATION AND INITIAL OPERATION

Start-up of chiller

■ After successful completion of all instructions given in this chapter, the refrigerating plant is switched on by means of the main switch or master switch (if installed). The **OPERATION** light will light up during normal operation.

Master switch position: **O = Off** **1 = Operation**

■ In case of irregularities occurring during operation or extraordinary noise, the chiller has to be switched off by means of the control switch (please contact the manufacturer).

■ Confirm the correct power supply connection. The direction of rotation of the fan motor must turn in the same direction as the arrow.

4 CARE AND MAINTENANCE

General

In case of irregularities occurring during operation or extraordinary noise, the chiller has to be switched off by means of the main switch or if missing over the power supply.

Fluid (water)

Cleanliness of the water/fluid should be tested daily. If required, the water/fluid has to be drained and the evaporator, tank and pump has to be rinsed or cleaned.

Drain water from the tank as follows:

- Option - Turn the water level sight glass (pipe) to the side (A)
- Option - drain water through water drain valve (B)
- Option - by disconnecting the quick coupling on the water inlet side while the pump is running

Attention: use a bucket (C).

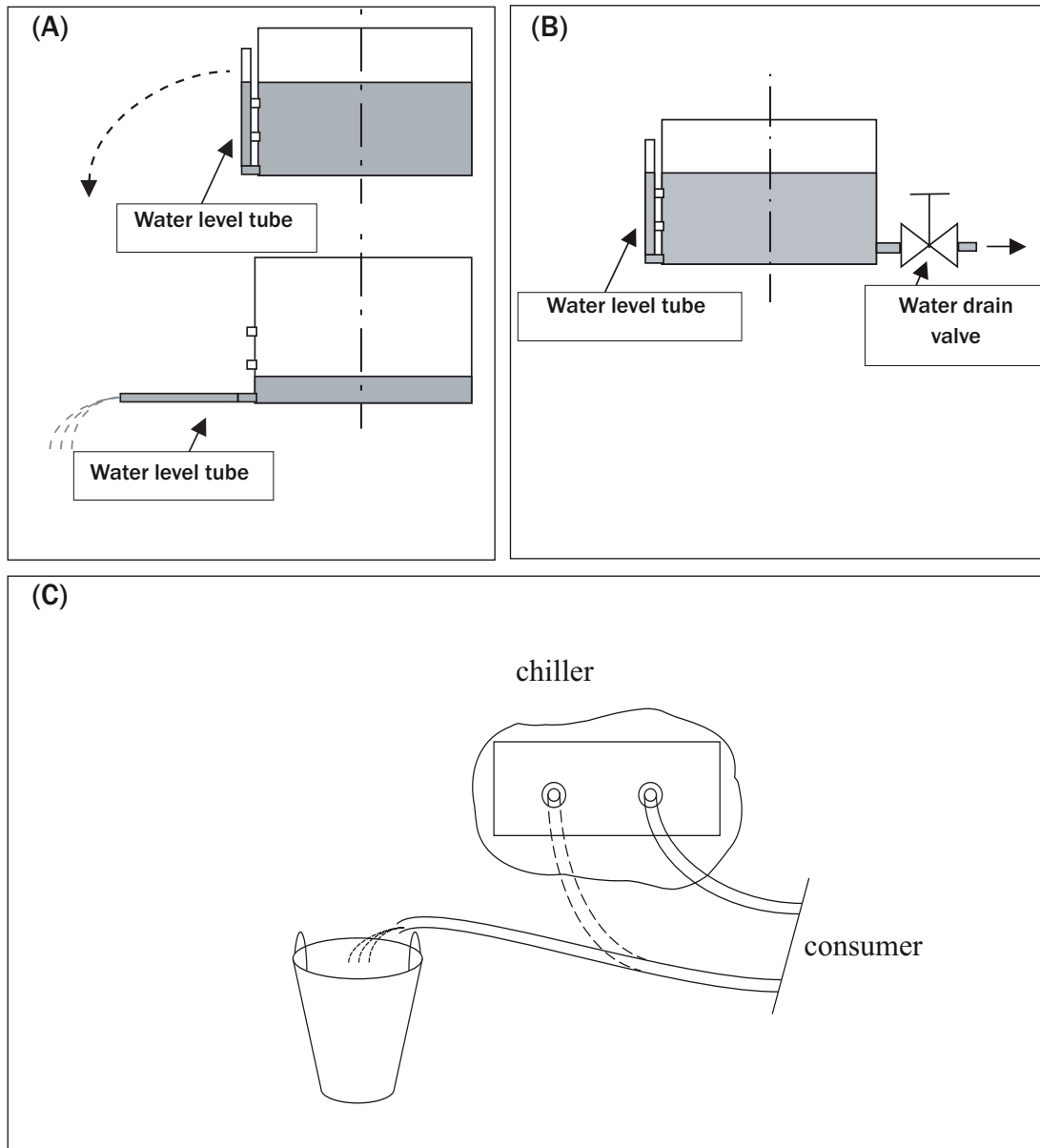

4 CARE AND MAINTENANCE



Refilling of fluid

Automatic refill (option)

Automatic water feed guarantees constant level in the tank, ensure that the evaporator always remains submerged. Float valve function has to be tested regularly.

Manual refill

Ensure that the evaporator is always submerged.

Water supply

Larger volumes of fresh water supply may disturb the equilibrium of mixture or reduce concentration of antifreezing agent. The content of concentration should be checked and determined at required intervals of time.

Standstill for prolonged period

Longer standstill of chiller requires draining of tank and complete water circuit. For renewed start-up of the chiller the same steps as for the initial start-up must be considered.

Cleaning of condenser (air-cooled chillers)

Make sure that the cooling fins of the condenser remain clean in order to guarantee the required heat exchange.

The condensor must be cleaned in monthly intervals or if required at shorter time intervals.

Dust and dirt clogging up the cooling fins should be removed by means of compressed air.

5 FAULT DIAGNOSIS

By means of the following instructions a quick failure analysis can be made. The user can repair some failures without any assistance. Please do not hesitate in phoning the manufacturers after sale service department if assistance is required.

Corrective maintenance of the refrigeration cycle must be performed by competent refrigeration specialists only. In case of any problems concerning the refrigeration cycle, please contact the manufacturer

Note:

Please ensure to switch »0« the main switch, before any maintenance or repairment work has to be performed on the chiller.



5 FAULT DIAGNOSIS

Fault Refrigeration cycle	Possible cause	Repairement
A. Compressor and fan motor running, but chiller has no cooling capacity	Refrigerant leakage - refrigerant level to low	Repairement by qualified refrigeration technician only
	Dirty condensor	Clean condensor
	Ambient temp. to high	Refer to technical specifications
	Consumer capacity to high	Refer to technical specifications
B. Compressor and fan motor is not running	Temperature controller setting incorrect	Re-adjustment of temp. controller
	Temperatur controller defect	Replacement by qualified technician only
	Fan Motor defect	Switch off the chiller and restart after 3 hours only. If compressor does not start, replacement by qualified refrigeration technician only. If compressor starts, refer to D.
C. Compressor does not run, but fan motor is running	Compressor Bimetal/Clixon switches compressor of due to overheating	Switch off the chiller and restart chiller after 3 hours only. If compressor does not start, replacement by qualified refrigeration technician only.
	If compressor starts after 3 hours	1. Refrigerant leakage - refrigerant level to low 2. Dirty condensor 3. Ambient temp. to high 4. Consumer capacity to high
D. Compressor is running, but fan motor does not run	Fan Motor defect	Replacement by qualified technician only.

5 FAULT DIAGNOSIS

Fault	Possible cause	Repairement
Water cycle Pump is not pumping any water	Air in the water cycle Pump fuse defect Pump defect	Refer to air bleeding instructions in Documentation Replace fuse Replacement by qualified technician only

6 IMPORTANT INFORMATION ON WATER QUALITY



In order to achieve a correct and trouble-free operation on your water chiller it is necessary to examine the water quality and, when necessary, carry out water treatment. Corrosion, furring and biological problems can occur in the water system.

The following information is important for the assessment of a half-open system:

- water quality
- all materials having contact with the cooling water
- max. and min. system water temperature
- requirements for water quality

1. Deionized / Demineralized / Distilled / Return Osmosis water

When using deionized, demineralized, distilled or return osmosis water it is required to add a corrosion inhibitor or glycol to the water system.

2. Fresh water/ City water / Tap water

When using fresh water, city water or tap water it is recommended to analyse the water by a specialist to minimize the risk of any chiller damage through a high chloride content. A high chloride content (>20mg/l) in the system water can cause corrosion on the stainless steel evaporator.

It is required to make use of a corrosion inhibitor as additive to the system water. We recommend the use of **Nalco 77382 at a concentration of 5g/l in the complete water system**, unless an Inhibitor with similar characteristics is prescribed from the manufacturer.

Organic sediments and algae in the water cycle can be controlled by analysing the number of organic germs. If the number of organic germs exceeds 1000 KBE/ml, we recommend to use

Biozid Nalco 77352 at a concentration of 100mg/l. After 3 to 4 days it is recommended to exchange the complete system water. The chiller can operate during this period.

Evaporation leads to a concentration of minerals and chloride in the system water, especially at the surface level. The water parameters which are initially below the guide values, can increase to exceed the guideline value as a result of the evaporation. An excessive chloride content in the system water will cause corrosion on the stainless steel evaporators and stainless steel tank. We therefore recommend to regularly monitor the water quality and if necessary drain the concentrated water from the system in order to rematch the water values to the parameters as per guideline. It is recommended to exchange the water at least once or more times per year and to inspect the evaporators on regular intervals.

Water quality parameters:

ph-value:	7-9	alkalinity (°dH):	<1
conductivity:	<300 µS/cm	chloride content:	<20 mg/L
hardness (°dH):	<0,1	organic germs:	<1000 KBE/ml

For any further questions please contact the water specialist (S. 16)

Ignorance of the above information cancels the Manufacturers liability for subsequent damage.

6 IMPORTANT INFORMATION ON WATER QUALITY

For assistance regarding watertreatment please contact:

GERMANY

Nalco Deutschland GmbH
Ludwig-Landmann-Strasse 405
D-60486 Frankfurt am Main
Phone: 069-793-40
Fax: 069-793-4295

FRANCE

Nalco
N°5 rue Rosa Bonheur
F-59290 Wasquehal
Phone: 03 20 11 70 00
Fax: 03 20 11 70 70

EUROPE

Nalco European Operations
2342 BV Oegstgeest
P.O. Box 627, NL-2300 Leiden, The Netherlands
Phone: 31-71-524-1100
Fax: 31-71-524-1197

USA

Nalco Company
Nalco Center
1601 W. Diehl Road
Naperville, IL 60563-1198 U.S.A.
Phone: 630-305-1000
Fax: 630-305-2900

SOUTH AMERICA

Nalco Latin America Operations
Av. Das Nacoes Unidas
17.891, 11o, Andar
Santo Amaro 04795-100
Sao Paulo, Brazil
Phone: 55-11-5644-6500
Fax: 55-11-5641-7687

ASIA

2 International Business
2-20 The Stategy Tower 2
Singapore 609930
Phone: 0065 (0) 68 61 40 11
Fax: 0065 (0) 68 61 40 11

7 PLATE HEAT EXCHANGER (OPTION)

Cleaning of plate exchanger

Soldered heat exchanger: For the removal of lime- and rust deposits, purifying agent SWEPcip AS, RS, CS or S (according to material) is suitable. Cleaning may be performed by means of SWEP cleaning device C.I.P 90 (circulation method) or a stationary pump.

Screwed heat-exchanger: In this case the heat exchanger can also be disassembled for cleaning.

Steel	Lime	Rust	Lime + Rust
	SWEPcip AS	SWEPcip RS	SWEPcip S
Max. Temp:	80 °C	80 °C	50 °C
Max. time:	8 h	8 h	8 h
Mixture ratio:	1:10	1:5	1:5

Stainless steel	Lime	Rust	Lime + Rust
	SWEPcip AS	SWEPcip CS	SWEPcip AS
Max. Temp:	80 °C	80 °C	80 °C
Max. time:	8 h	8 h	8 h
Mixture ratio:	1:10	1:5	1:10

See attached concept for further technical data

8 Waste disposal

The refrigerant cycle of the chiller contains an environment friendly refrigeration fluid. Only registered and qualified refrigeration companies are permissible to carry out work on the chiller. Before attending any repairs or maintenance work on the refrigeration cycle the refrigerant must be recovered by means of a recovery unit. Any intention blowing off the refrigerant is prohibited. Disposal of the refrigerant and any other parts like compressor oil or waste water must be completed according to local regulations only.

Specification subject to change.

FOR YOUR NOTICE

TECHNICAL DATA SHEET

(89028)

Kühlwasser-Rückkühler
Typ Chilly 45-S

1. GENERAL DATA

Refrigerant gas:		R407C	
<u>Specifications:</u>			
Nominal ambient air:	°C	37	
Coolant temperature:	°C	10 15 20	
Cooling Capacity:	W	3450 4395 5340	
Min ambient air:	°C	10	
Max ambient air:	°C	42	
Min coolant temperature:	°C	10	
Max coolant temperature:	°C	25	
Evaporator material:		Stainless steel 1.4301	
Temperature control:		electronic, direct	
Temperature display:		digital	
Control voltage:		230V AC	
Main Power supply:		1/N/PE/50Hz 230V/+-10%	
Total absorbed power:	kW		max: 2.7
Full load current:	A		max: 12.2
Safety fuse protection:	A	16.00	
Sound-pressure-levels in 1m Distance:	dB(A)	70.00	
Paint:		RAL 3020	
<u>2. AIR CONDENSER:</u>			
		air cooled, axial	
Nominal Air Flow:	m³/h	1210.00	
Number of fan:	Unit	1	
Nom Absorbed power:	kW	0.11	
Starting current:	A	1.20	
Sound-pressure-levels in 1m Distance:	dB(A)	62.20	
<u>3. COMPRESSOR:</u>			
		reciprocating	
Number:	Unit	1	
Technology:		direct	
Total absorbed power:	kW		max: 1.88
Full load current:	A		max: 7.60
<u>4. PUMP:</u>			
First PUMP:		horizontal centrifugal pump	
Type:		CM1-4	

Number:	Unit	1
Total absorbed power:	kW	0.50
Full load current:	A	3.10
Nominal flow rate:	m³/h	0.77
Nominal pressure rate:	bar	2.30

5. LIQUID TANK: plastic

Volume:	l	30.00
Outlet / inlet connections:	Inch	1/2

6. WEIGHT AND PHYSICAL SIZE:

Length:	mm	757
Width:	mm	609
Height:	mm	479
Weight :	kg	90

Füllmenge Kühlflüssigkeit / Coolant filling capacity

Wasser-Rückkühler / Water chiller	Füllmenge Kühlflüssigkeit / Coolant filling capacity	Kältemittel / Refrigerant
Chilly 08	18l (4.75 gal)	R407C 0,63 kg
Chilly 15	18l (4.75 gal)	
Chilly 25	18l (4.75 gal)	
Chilly 35	30l (7.9 gal)	
Chilly 45	30l (7.9 gal)	

WICHTIG! Tank mindestens so lange füllen, bis der Verdampfer (Kühlschlange) bedeckt ist.

IMPORTANT! Fill the tank until the evaporator is covered.

Kühlflüssigkeit bestellen / Order coolant

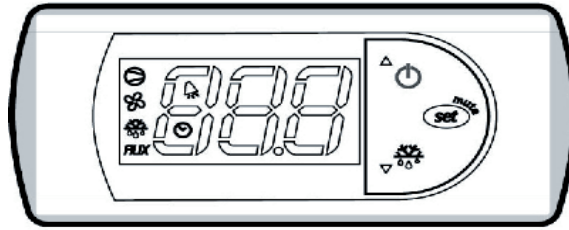

Kanistervolumen / Canister capacity	Artikelnummer / Article number
5l (1.3 gal)	40,0009,0046
30l (7.9 gal)	40,0009,0075

Description of the Digital controller



Temperature - setting:

Press the `` SET `` key for 1 second until the current temperature value appears.

With the key  and  the values can be adjusted and must be confirmed with `` SET `` key.

The min / max temperature set values are restricted by the manufacturer.

Parameter	Set Value	Description
ST 1	15°C	<ul style="list-style-type: none"> ➔ Mode: cooling ➔ Can be adjusted within the restricted values

Adjustment of controller by manufacturer:

OUT 1: Set point is set on 15°C by factory. Relay switches on cooler as soon as temperature is exceeded.

OUT 2: provides a fault signal: temperature to low, temperature to high and water level or water flow to low.
(Option)

Indication of display:

In normal operation display indicates actual values measured by the sensor of medium.

Hysteresis:

Hysteresis is set by the factory and this value must not be changed.

Fault Analyses:

During an alarm, an acoustic signal is released, this can be discontinued by pressing the “SET” key.

Indication	Description	Cause	Correction
E0	Failure: Sensor	<ul style="list-style-type: none"> ➔ Sensor cable broken or short circuited ➔ Connection failure ➔ Sensor defective 	<ul style="list-style-type: none"> ➔ Check connections between sensor and thermostat ➔ Check sensor and thermostat 10 kΩ bei 25°C
IA	Failure digital input:	<ul style="list-style-type: none"> ➔ Water level or waterflow to low 	<ul style="list-style-type: none"> ➔ Examine water level ➔ Dirty consumer
HI	Alarm “HI“	<ul style="list-style-type: none"> ➔ Temperature of medium 10°C above set point 	<ul style="list-style-type: none"> ➔ Temperature of medium too high
LO	Alarm “LO“	<ul style="list-style-type: none"> ➔ Temperature of medium 3°C below set point 	<ul style="list-style-type: none"> ➔ Temperature of medium too low

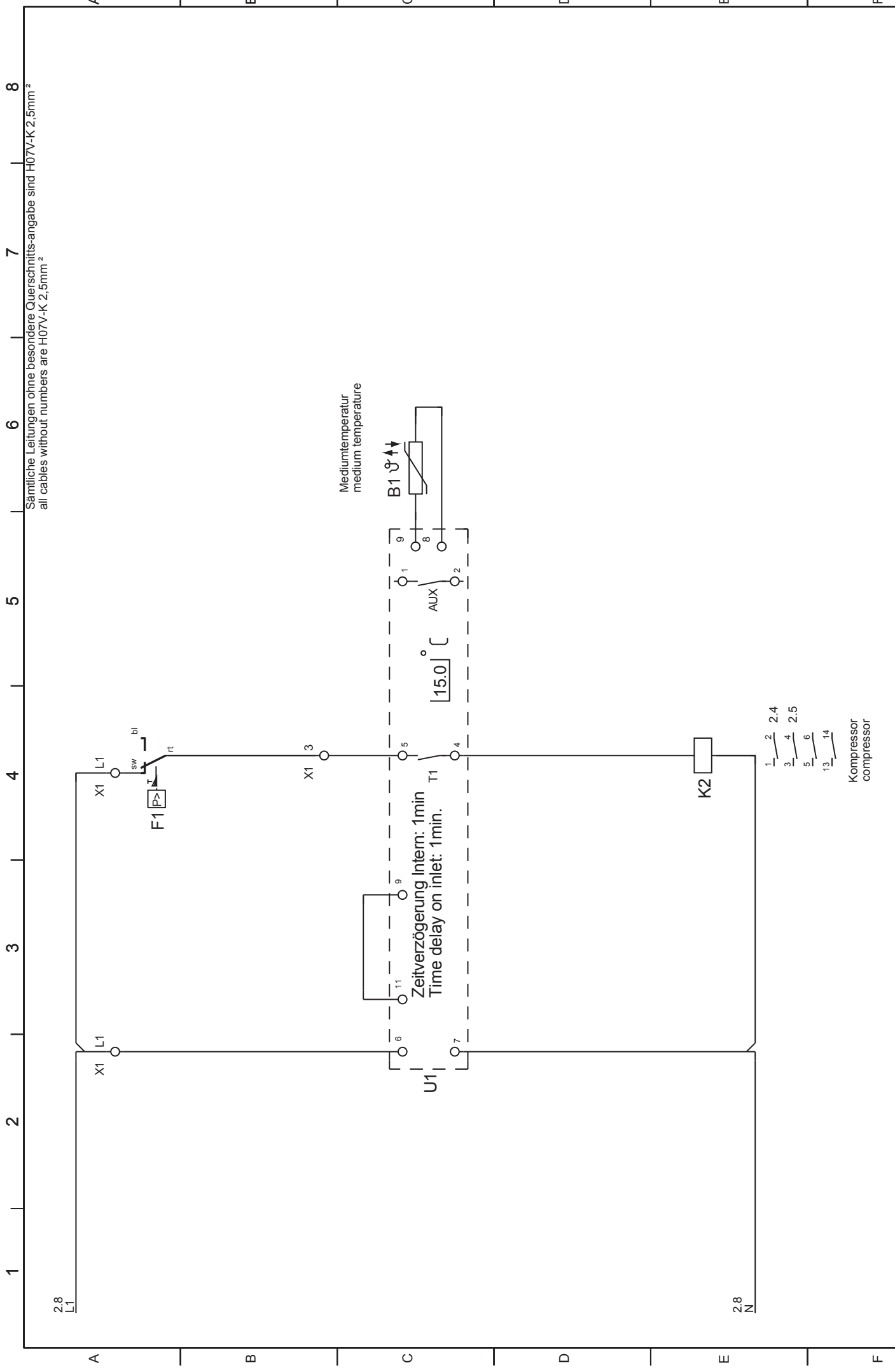

Sämtliche Leitungen ohne besondere Querschnitts-angabe sind H07V-K 2,5mm²
all cables without numbers are H07V-K 2,5mm²

Zust. Änderung	Datum	Name	Norm	Urspr.	Ers. f.	Ers. d.
	Datum	Bearb.	Gepr.			
Hauptstromkreise Main circuit						Zeichng. Nr. E0011232
						Typ Chilly 45-S
						Blatt 3
						von 4 Blatt

Pos.	Beschreibung / Description:	Type:	Art.Nr:
B1	Fühler / sensor	NTC 030WP00, 3,0m Kabel, IP 67	48,0005,1053
C1	Kondensator / Condenser	88µF-330V, Code no. .640.151	48,0005,1639
C2	Kondensator / Condenser	35µF	48,0005,1638
F1	Hochdruckbegrenzer / high pressure limiter	ACB 061F9248	48,0005,1616
K1	Schütz / contactor	RVA 4 L 3 D für FH 5522C "F"	48,0005,1640
K2	Schütz / contactor	3TG10 10-OAL2	48,0005,1619
M1	Kompressor / compressor	FH 5522C, PSC,240/1/50	48,0005,1641
M2	Lüfter / fan	FMV S355VD43MGC30W4	48,0005,1636
M3	Pumpe / pump	CM1-4, 1x 230V,50Hz	48,0005,1081
Q1	Hauptschalter / main-switch	H216-41300-2X062	48,0005,0976
U1	Thermostat / thermostat	PJEZS0G000	48,0005,1498





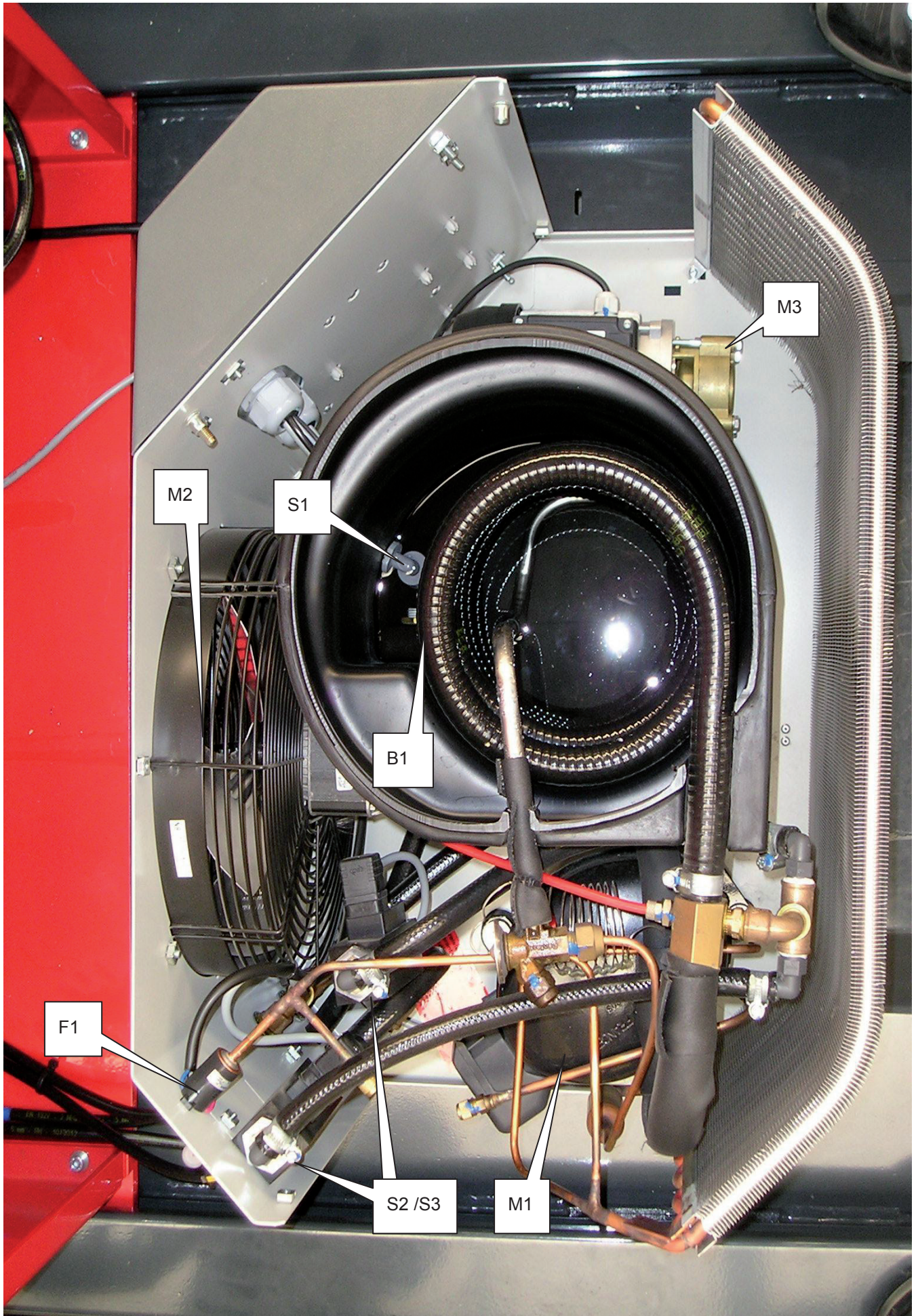



Füllstandsanzeige / level indicator

F1

S2

Verschlusskupplung / connect coupling

Stecknippel / plug grommet

F2/Sicherungs-
Halter / fuse
holder



F2/Sicherung
/ fuse



C1/Kondensator
/ capacitor
19037



K2/K3/Schütz /
contactor
17891



U1/Regler /
controller
34736

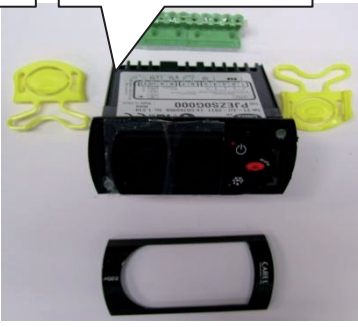

Q1/Hauptschalter
/ main switch
18315



Harting



Verschraubung /
twisting 20542

Tüllengehäuse / housing 34288

M1/Kompressor inkl.
Beipack / Compressor with
accessory kit
17009



C1

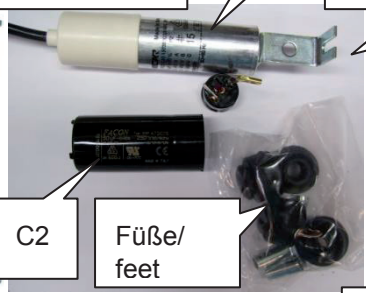

Stifteinsatz / Plug 28387
Beipack Kompressor/C1/C2/K1/Füße
/accessory kit /feet

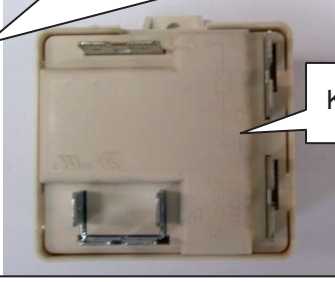

K1

C2

Füße/
feet

B1/Fühler/ sensor 10197



F1/Hochdruck /
high pressure
28766



S1/Schwimmerschalter / level switch 37206



S2/S3/Strömungswächter /
flow switch 39174

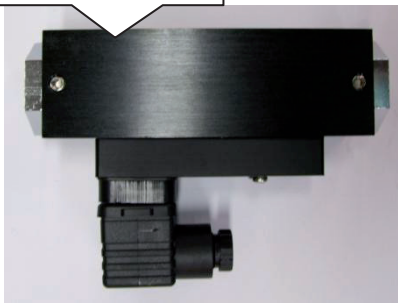

M2/Lüfter / fan 17015



M3/Pumpe / pump 49219



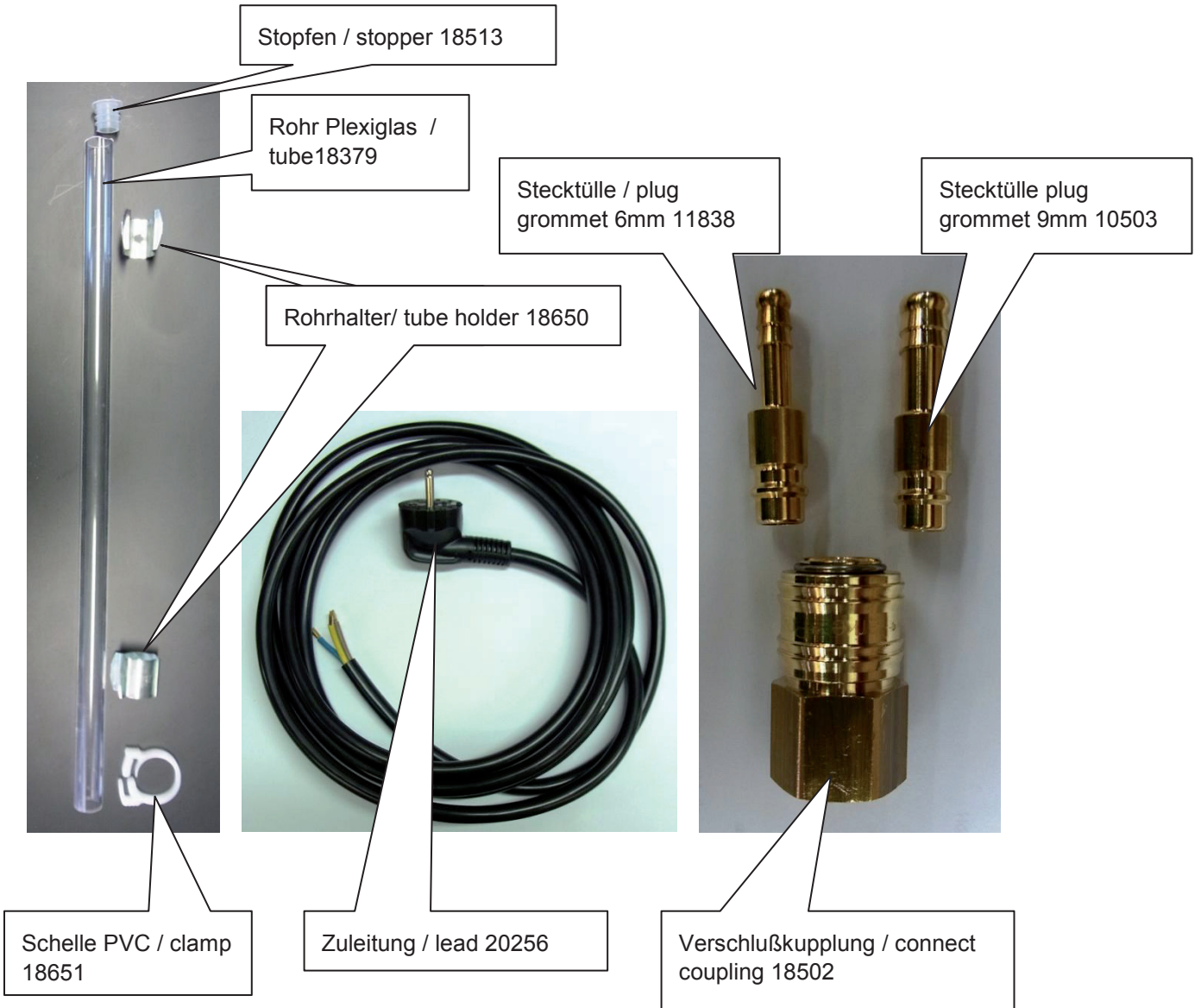

Einstellungen am Strömungswächter vornehmen.

Auf der Rückseite des Strömungswächters befindet sich ein Reedkontakt **(1)** welcher einen eingestellten Wert überwacht. Wird dieser Wert über- unterschritten wird der Reedkontakt geöffnet und somit eine Fehlermeldung ausgegeben.
Zum verstellen des zu überwachenden Wertes muss die Schraube **(2)** gelöst werden.
Durch Verschieben des Reedkontakt **(1)** kann der Einstellwert verstellt werden.
Nach Beendigung der Einstellung muss die Schraube **(2)** wieder festgestellt werden.

Flow switch setting

On the back of the flow switch is a reed contact **(1)** that monitors a set value. If this value is exceeded the reed contact give the signal for error message.
For the value to be monitored to adjust the screw **(2)** can be solved. By moving the reed switch **(1)** the setting can be adjusted. After setting, the screw **(2)** must be determined.

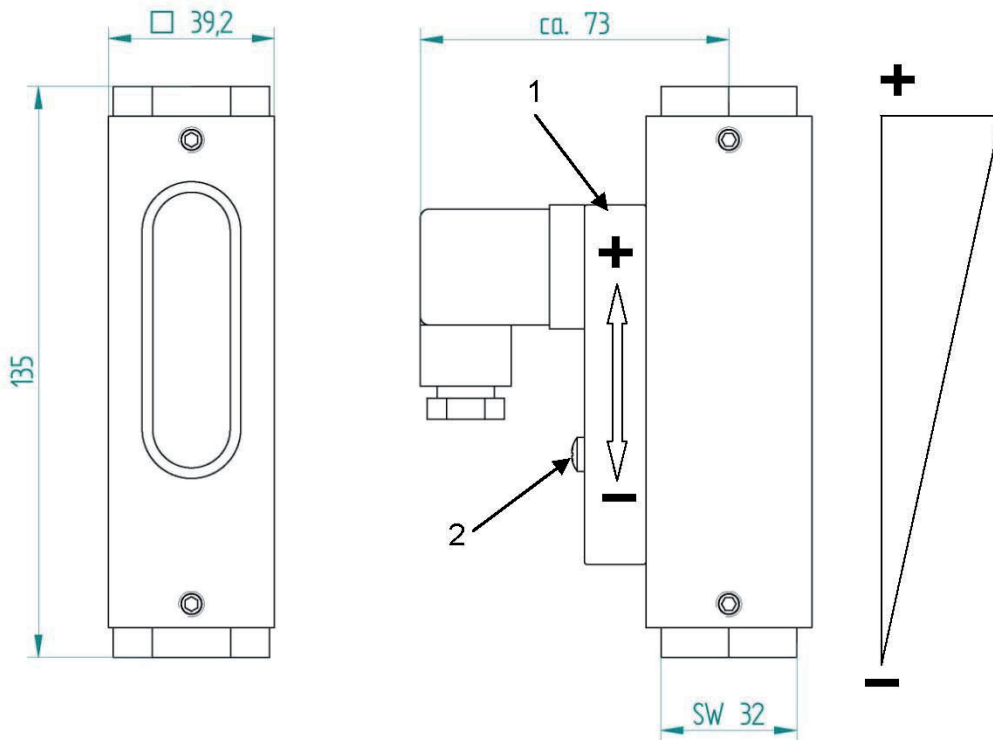

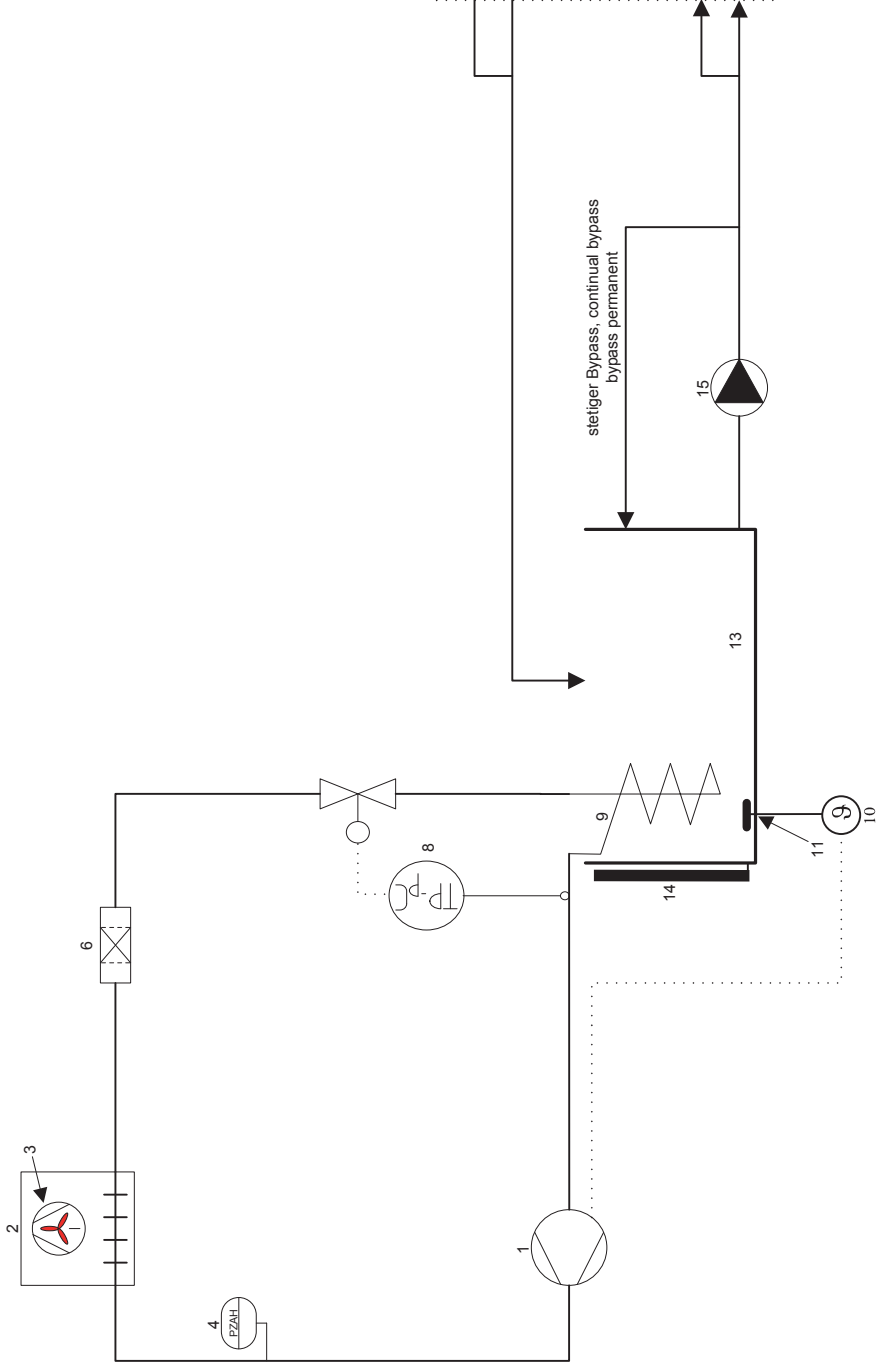

steitiger Bypass, continual bypass
bypass permanent

Nr.	dt.	engl.	franz.
1	Kompressor	compressor	compresseur
2	Verflüssiger	condenser	condenseur
3	Lüfter	fan	ventilateur
4	HD- Pressostat	hp- switch	pressostat HP
6	Trockner	drier	déshydrateur
8	Expansionsventil	expansion valve	détendeur
9	Verdampfer	evaporator	évaporateur
10	Thermostat	thermostat	thermostat
11	Fühler	sensor	sonde
13	Tank	tank	bac
14	Füllstandsanzeige	fluid level indicator	niveau visuel
15	Pumpe	pump	pompe

Fließschema/ hydraulic schema/ schéma hydraulique

Type: Chilly 08-45

bearbeitet	geprüft	ZEICHN. NR.
DATUM 24.08.2009	DATUM 24.08.2009	F1217
		Blatt 1 von 1



EU-KONFORMITÄTSERKLÄRUNG 2016
EU-DECLARATION OF CONFORMITY 2016
DÉCLARATION UE DE CONFORMITÉ, 2016

Wels-Thalheim, 2016-04-20

Die Firma

Manufacturer

La compagnie

FRONIUS INTERNATIONAL GMBH

Froniusplatz 1, 4600 Wels

erklärt in alleiniger Verantwortung,
dass folgendes Produkt:

Hereby certifies on its sole
responsibility that the following
product:

se déclare seule responsable du fait
que le produit suivant:

Chilly 08 50/60 Hz
Chilly 15 50/60 Hz
Chilly 25 50/60 Hz
Chilly 35 59/60 Hz
Chilly 45 50/60 Hz
Kühlgerät

Chilly 08 50/60 Hz
Chilly 15 50/60 Hz
Chilly 25 50/60 Hz
Chilly 35 59/60 Hz
Chilly 45 50/60 Hz
cooler unit

Chilly 08 50/60 Hz
Chilly 15 50/60 Hz
Chilly 25 50/60 Hz
Chilly 35 59/60 Hz
Chilly 45 50/60 Hz
dispositif de refroidissement

auf das sich diese Erklärung
bezieht, mit folgenden Richtlinien
bzw. Normen übereinstimmt:

which is explicitly referred to by this
Declaration meet the following
directives and standard(s):

qui est l'objet de la présente
déclaration correspondent aux
suivantes directives et normes:

Richtlinie 2006/42/EG
Maschinenrichtlinie
Richtlinie 2014/30/EU
Elektromag. Verträglichkeit

Directive 2006/42/EC
Machinery Directive
Directive 2014/30/EU
Electromag. compatibility

Directive 2006/42/CE
Directive aux machines
Directive 2014/30/UE
Électromag. Compatibilité

Europäische Normen inklusive
zutreffende Änderungen
EN ISO 12100:2010
EN 60204-1:2006
EN 61000-6-2:2005
EN 61000-6-4:2007
EN 378-1-4:2012

European Standards including
relevant amendments
EN ISO 12100:2010
EN 60204-1:2006
EN 61000-6-2:2005
EN 61000-6-4:2007
EN 378-1-4:2012

Normes européennes avec
amendements correspondants
EN ISO 12100:2010
EN 60204-1:2006
EN 61000-6-2:2005
EN 61000-6-4:2007
EN 378-1-4:2012

Die oben genannte Firma hält
Dokumentationen als Nachweis der
Erfüllung der Sicherheitsziele und
die wesentlichen Schutzanforder-
ungen zur Einsicht bereit.

Documentation evidencing
conformity with the requirements of
the Directives is kept available for
inspection at the above
Manufacturer.

En tant que preuve de la satisfaction
des demandes de sécurité la
documentation peut être consultée
chez la compagnie susmentionnée.

Dokumentationsverantwortlicher:
(technische Dokumentation)

person responsible for documents:
(technical documents)

responsable documentation:
(technique documentation)

Ing. Josef Feichtinger
Günter Fronius Straße 1
A - 4600 Wels-Thalheim

Ing. Josef Feichtinger
Günter Fronius Straße 1
A - 4600 Wels-Thalheim

Ing. Josef Feichtinger
Günter Fronius Straße 1
A - 4600 Wels-Thalheim

CE 2016

ppa. Mag. Ing. H. Hackl
Member of Board
Chief Technology Officer



FRONIUS INTERNATIONAL GMBH

TechSupport Automation

Froniusplatz 1, A-4600 Wels, Austria

E-Mail: support.automation@fronius.com

www.fronius.com

www.fronius.com/addresses

Under <http://www.fronius.com/addresses> you will find all addresses
of our Sales & service partners and Locations.

